

Instruction Manual

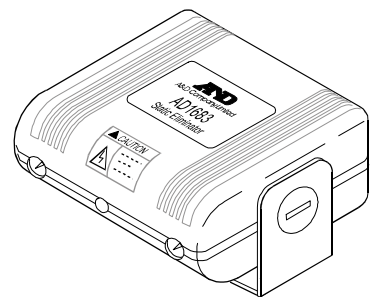

© 2004 A&D Company Ltd. All rights reserved.

No part of this publication may be reproduced, transmitted, transcribed, or translated into any language in any form by any means without the written permission of A&D Company Ltd.

The contents of this manual and the specifications of the instrument covered by this manual are subject to change for improvement without notice.



WM+PD4000962

To Use the AD-1683 Safely

Thank you for your purchasing the AD-1683 DC static eliminator. Please read this manual completely before using the AD-1683.

Warning Definition
The warning described in this manual has the following meaning:

Caution Important information to alert you to a situation that may cause injury and/or damage to your property if instructions are not followed.

When operating this instrument, be sure to observe the following safety precautions

Caution

- Do not open the case to repair the AD-1683. Only qualified personnel can do that. Attempting repairs yourself may cause damage to the AD-1683. Damage caused by attempting to do the repair yourself will void the warranty.
- Do not use the AD-1683 in a closed environment. Ozone that is harmful to the human body may stray into the air. Ventilate well.
- The AD-1683 is not explosion-protected. Do not use the instrument where flammable solvents or dust exists.
- Do not touch the discharge electrode pins. It may cause an electrical shock.
- Use the specified AC adapter only. Please confirm that the AC adapter type is correct for your local voltage and receptacle type. If an AC adapter other than specified is used, static electricity may not be eliminated or it may cause an electrical shock. (*1)
- Be sure to insert the AC adapter into a grounding-type electrical outlet and earth ground the grounding cable. Otherwise, static electricity may not be eliminated or it may cause an electrical shock.

*1: Use the AC adapter identification label to identify the AC adapter.

Caution

- Do not keep the AC adapter connected to the electrical outlet for a long period of time. Dust that has collected on the outlet may cause a fire.
- When relocating the AD-1683, remove the AC to avoid a possible electrical shock.

Precautions on Usage

Caution

- If the AD-1683 malfunctions, stop using it immediately. Place an "Out of Order" label on it or move the instrument to a place where it can not be used by mistake. It is very dangerous to continue using the instrument under such conditions. Ask the nearest dealer for services.
- Do not face the front of the AD-1683 directly toward an electronic balance. Ionized air from the AD-1683 may affect the measurement and cause a measurement error.
- When used with a balance of other manufacturers, static elimination can not be guaranteed.
- Do not place the sample closer to the AD-1683 than specified. The sample may become charged.
- Do not place any obstacle between the AD-1683 and the sample.
- The stand can be attached to the workbench. The stand has three holes with a diameter of 6 mm in 42.5 mm interval for that purpose. (To secure the stand: Bend the side plates outward to remove the AD-1683, using much care not to separate the upper and lower cases. Attach the stand to the workbench using the screws. Replace the AD-1683 on the stand.)

1. Introduction

This manual describes how the AD-1683 works and how to get the most out of it in terms of performance. Please read this manual completely before using the AD-1683.

2. Features

The AD-1683 generates bipolar ions continuously by DC corona discharge separately from positive and negative discharge electrodes and directs the ionized air onto the charged body to eliminate static electricity. The generated ions are well-balanced in polarity and can eliminate static electricity regardless of the polarity of the charged body. (See Fig.3.)

Static electricity
Generally, insulators such as plastics are prone to be charged with static electricity when the ambient relative humidity is below 45%RH. This may affect weighing and cause a measurement error of several milligrams. The AD-1683 can eliminate static electricity very effectively.

3. Part Names

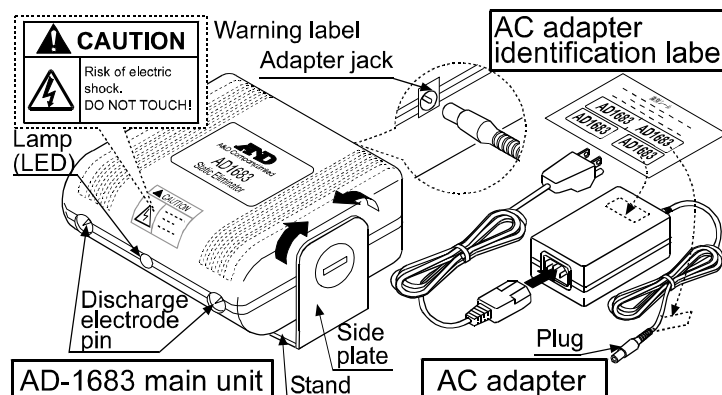

Note: Please confirm that the AC adapter type is correct for your local voltage and receptacle type. To prevent electrical shock, insert the POWER cable into a grounding-type outlet and earth ground the grounding cable.

4. How to Use the AD-1683

4-1. Installing the AD-1683

Choose the installation site so that the AD-1683 can be placed beside the electronic balance and a space wide enough to place a sample (10 cm to 30 cm from the front of the AD-1683) can be secured. Place the sample in front of the AD-1683 inside the specified area and perform static elimination. Then, weigh the sample using the electronic balance.

Fig.1 Example of AD-1683 installation

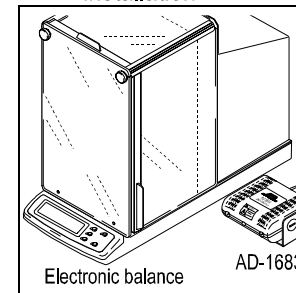

Fig. 2 Distribution of static eliminating ions

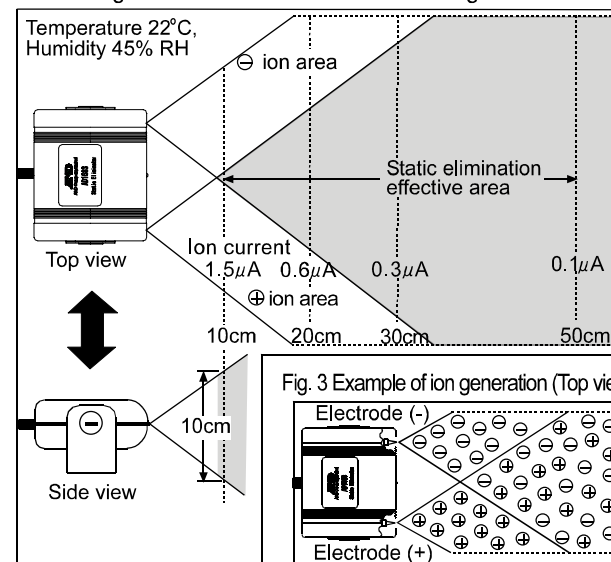
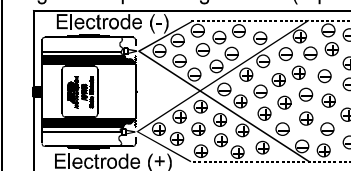

Fig. 3 Example of ion generation (Top view)



4-2. Turning the power on

Insert the AC adapter plug to the AC adapter jack located on the rear of the AD-1683. Insert the AD adapter into an electrical outlet. The red LED at the center of the AD-1683 illuminates to indicate that static elimination is available.

Note: Please confirm that the AC adapter type is correct for your local voltage and receptacle type..

4-3. Finishing the use

Remove the AD adapter from the electrical outlet.

5. Maintenance

5-1. Cleaning

Caution

Remove the AC adapter from the AD-1683 before cleaning.

When used for a long period of time, dust may collect around the discharge electrode pins and static elimination performance will be lowered. To maintain the elimination performance, clean the AD-1683 periodically (once a week). Use a cotton swab to clean the electrode pins.

Fig.4 Cleaning the discharge electrode pin

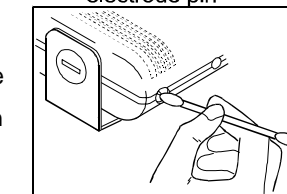

5-2. Replacing the discharge electrode pin

When the elimination performance remains low even after cleaning the discharge electrode pins, replace the discharge electrode pins with new ones. Remove the AC adapter from the receptacle and the AD-1683. Using a pair of pliers, pull the discharge electrode pin out. Insert a new pin, using much care not to bend the pin tip. Be sure to insert the pin till stopped.

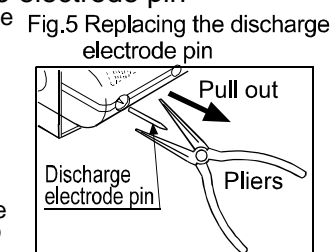

Replacement discharge electrode pins (Sold separately):
AX-054016580-S

6. Specifications

| | | | | | |
|----------------------------------|---|-------|-------|--------|--------|
| Static elimination method | DC corona discharge (Bipolar) (See Fig. 2) | | | | |
| Elimination range | Distance: Approx. 10 cm to 30 cm from the electrode Area : 30x30 cm from the electrode | | | | |
| Elimination performance | When charged 5 kV | | | | |
| | Distance | 10cm | 20cm | 30cm | 50cm |
| | Elimination time | 1 sec | 4 sec | 15 sec | 70 sec |
| Ambient temperature and humidity | 0°C to 40°C, 80%RH or less | | | | |
| Ozone concentration | Positive discharge pin: 0.07PPM Negative discharge pin: 0.25PPM (Measured at a distance of 1 cm from each discharge pin.) | | | | |
| Power supply | AC adapter. Please confirm that the AC adapter type is correct for your local voltage and receptacle type. | | | | |
| Power consumption | Approx. 1.5 VA | | | | |
| Discharge electrode pin | Tungsten (φ0.9x17 mm), Life Approx. 10000 hours | | | | |
| Mass | Approx. 300 g (including the stand) | | | | |

External Dimensions

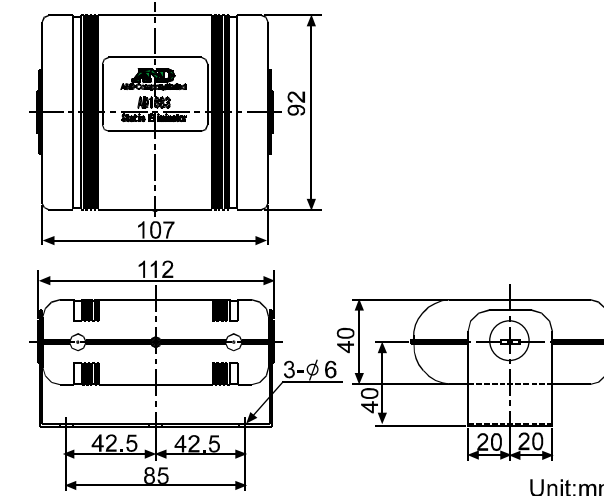

Unit:mm



A&D Company, Limited
3-23-14 Higashi-Ikebukuro, Toshima-ku, Tokyo 170-0013 JAPAN
Telephone: [81] (3) 5391-6132 Fax: [81] (3) 5391-6148